

TRiexpert LS

TRiexpert

TRi

Instructions for installation and use - English
Salt water chlorinator
Translation of the original instructions in french

EN

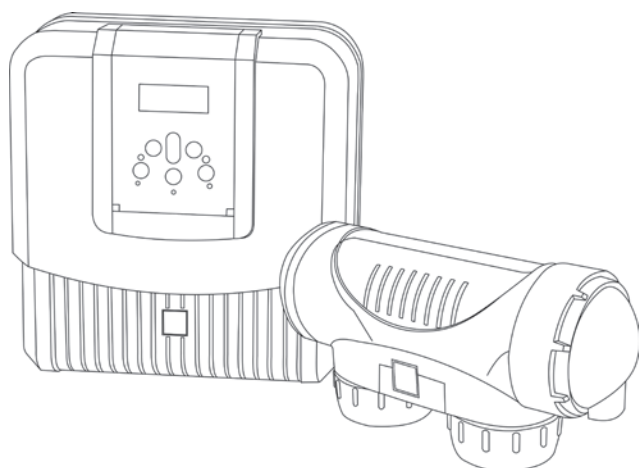

More documents on:
www.zodiac.com

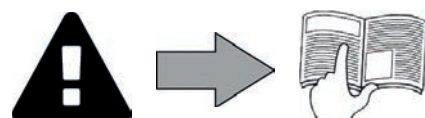

WARNINGS

GENERAL WARNINGS

- Failure to respect the warnings may cause serious damage to the pool equipment or cause serious injury, even death.
- Only a person qualified in the technical fields concerned (electricity, hydraulics or refrigeration) is authorised to perform this procedure. The qualified technician working on the appliance must use/wear personal protective equipment (such as safety goggles and protective gloves, etc.) in order to reduce the risk of injury occurring when working on the appliance.
- Before servicing the appliance, ensure that it is switched off and isolated from the power supply circuit.
- The appliance is intended to be used only for swimming pools and spas; it must not be used for any purpose other than that for which it has been designed.
- It is important that the appliance is operated by people who are competent and qualified (both physically and mentally), after having read the instructions for use. Persons not meeting these criteria should not be allowed access to the appliance in order to prevent risk of property damage or injury, including loss of life.
- Keep the appliance out of the reach of children.
- The appliance must be installed according to the manufacturer's instructions and in compliance with all applicable local and national standards. The installer is responsible for installing the appliance and for compliance with national installation regulations. Under no circumstances may the manufacturer be held liable in the event of failure to comply with applicable local installation standards.
- For any work other than the simple user maintenance described in this manual, the product should be referred to a qualified professional.
- Incorrect installation and/or use may cause serious damage to property or serious injuries (possibly causing death).
- All equipment, even postage and packing paid, travels at the risks and perils of the recipient. The latter shall issue reserves in writing on the carrier's delivery slip if damage is detected, caused during transport (confirmation to be sent to the carrier within 48 hours by registered letter). In the event that an appliance containing coolant has been turned on its side, mention your reservations in writing to the carrier.
- If the appliance suffers a malfunction, do not try to repair it yourself; instead contact a qualified technician.
- Refer to the warranty conditions for details of the permitted water balance values for operating the appliance.
- In addition to using spare parts manufactured by unauthorised third-party manufacturers, deactivating, eliminating or bypassing any of the safety mechanisms integral to the appliance, will automatically void the warranty.
- Do not spray insecticide or any other chemical (inflammable or non-inflammable) in the direction of the appliance, as this may damage the body and cause a fire.
- Zodiac® heat pump, filtration pump and filter appliances are compatible with the most commonly used types of pool water treatment systems.
- Do not touch the fan and/or any moving parts and do not insert anything, including your fingers in the vicinity of the moving parts while the appliance is in operation.

WARNINGS ASSOCIATED WITH ELECTRICAL APPLIANCES

- The electrical supply to the appliance must be protected by a dedicated 30 mA differential residual current protection device (RCD), complying with the standards and regulations in force in the country where it is installed.
- Do not use an extension cord to plug in the appliance; connect the appliance directly to a suitable power supply circuit.
- Before carrying out any operations, check that:
 - The voltage indicated on the rating plate of the appliance corresponds to the mains voltage,
 - The power grid is adapted to the power requirements of the appliance, and is grounded.
 - The plug (where applicable) is suitable for the socket.
- In the event of abnormal function or signs of overheating such as a burning odour from the appliance, turn it off immediately, unplug / disconnect it from its power supply and contact a professional.
- Before accessing the enclosure for any reason, ensure that all power to the appliance and also power to any accessories or external devices which may be connected to the appliance, is disconnected from the mains power supply.
- Do not disconnect and reconnect the appliance to the power supply when in operation.
- Do not pull on the power cord to disconnect it from the power supply.
- If the supply cord is damaged, it must be replaced by the manufacturer, its service agent or similarly qualified persons in order to avoid a hazard.
- Do not attempt to carry out any servicing or maintenance operations with wet hands or while the appliance is wet.
- Ensure that all terminals for mains power are free in good condition and free of corrosion and/or dirt/debris.
- For any component or sub-assembly containing a battery: do not recharge or dismantle the battery, or throw it into a fire. Do not expose it to high temperatures or direct sunlight.
- In stormy weather, disconnect the appliance from the power supply to prevent it from suffering lightning damage.
- Do not immerse the appliance in water (with the exception of cleaners) or mud.

Recycling



This symbol means that your appliance must not be thrown into a normal bin. It will be selectively collected for the purpose of reuse, recycling or transformation. Any substances it may contain which are potentially dangerous to the environment shall be eliminated or neutralised.

Request information on recycling procedures from your retailer.





- Before you do anything with the device, it is vital that you read this installation and user manual, as well as the "warnings and warranty" booklet delivered with the device. Failure to do so may result in material damage or serious or fatal injury and will invalidate the warranty.
- Save these instructions for future reference for service and maintenance.
- It is prohibited to distribute or modify this document in any way without authorisation from Zodiac®.
- Zodiac® is constantly developing its products to improve their quality; therefore, the information contained in this document may be modified without notice.

Contents

<u>1. Information before installing</u>	3
1.1 Contents	3
1.2 Technical specifications	3
<u>2. Installation</u>	4
2.1 Preparing the pool: water balance	4
2.2 Installing the power pack.....	5
2.3 Installing the cell.....	5
2.4 Installing the flow controller.....	6
2.5 Electric connections.....	6
<u>3. Use</u>	9
3.1 User interface presentation	9
3.2 Settings	10
<u>4. Maintenance</u>	13
4.1 Cleaning the electrode.....	13
4.2 Winterizing	13
<u>5. Troubleshooting</u>	14

1. Information before installing

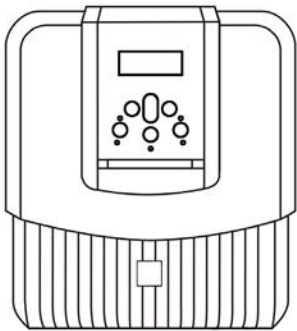
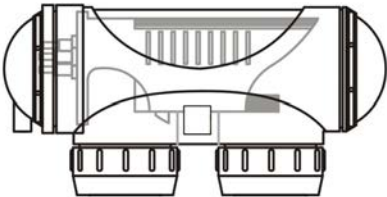
1.1 Contents

			
Power pack	Cell	Flow controller kit	Bag of accessories

1.2 Technical specifications

	TRi 10 TRi Expert 10	TRi Expert LS 10	TRi 18 TRi Expert 18	TRi Expert LS 18	TRi 22 TRi Expert 22	TRi 35 TRi Expert 35
Nominal chlorine production	10 g/h		18 g/h		22 g/h	35 g/h
Nominal output Amps	2,8 A	2,8 A	3,6 A	3,6 A	5 A	7,2 A
Required salt level - minimum	4 g/L (mini 3,3 g/L)	2,2 g/L (mini 1,6 g/L)	4 g/L (mini 3,3 g/L)	2,2 g/L (mini 1,6 g/L)	4 g/L (mini 3,3 g/L)	4 g/L (mini 3,3 g/L)
Power supply voltage	230Vac-50Hz					
Electric power	195W					
Protection index	IP23					
Box size (l x h x d)	31 x 33 x 11 cm					
Cell size (L x d)	30 x 10 cm					
Weight (box + cell)	7 Kg					
Flow through the cell (minimum / maximum)	5m ³ /h < 18m ³ /h					
Maximal pressure in the cell	2,75 bars					
Operating water temperature	5°C < 40°C					

2. Installation

2.1 Preparing the pool: water balance

These appliances are designed to disinfect pool water using its salt water chlorination function.

It is essential that the pool water balance and salinity are controlled and adjusted before the appliance is installed. Making sure that those parameters are correct from the very start will reduce the likelihood of encountering problems on the first days of operation or during the season the pool is in use.

i Even though it is an autonomous system, it is essential to regularly analyse the water to check the water balance parameters.

	Unit	Recommended values	To increase	To reduce	Test frequency (in the season)
pH	/	7.2 – 7.4	Add pH+ or use automatic regulation	Add pH- or use automatic regulation	Weekly
Free chlorine	mg/L or ppm	0.5 – 2	Increase the appliance's disinfectant production or use the Boost mode	Reduce disinfectant production	Weekly
TAC (alkalinity or buffering power)	°f (ppm)	8 – 15 (80 – 150)	Add alkaline corrector (Alca+ or TAC+)	Add hydrochloric acid	Monthly
HL (level of calcium carbonate)	°f (ppm)	10 – 30 (100 – 300)	Add calcium	Add a calcium carbonate sequestering agent (Calci-) or carry out carbonate removal	Monthly
Cyanuric acid (stabiliser)	mg/L or ppm	< 30	Only add cyanuric acid if necessary (Chlor Stab)	Partially empty the pool and refill it	Quarterly
Salinity	g/L or kg/m ³	2.2 (TRi Expert LS) 4 (TRi - TRi Expert)	Add salt	Leave as such or partially empty the pool and refill it	Quarterly
Metals (Cu, Fe, Mn, etc.)	mg/L or ppm	± 0	/	Add a metal fixer (Metal Free)	Quarterly

EN

2.2 Installing the power pack

- The control box must be installed in a dry and ventilated equipment room protected against frost, with no pool maintenance products stored nearby.
- The control box must be installed a minimum of 3.5m from the surrounding edge of the pool. Any additional local installation codes in the installation country must also be adhered to.
- It must not be installed more than 1.8 metres from the cell (maximum cable length).
- If the pack is fixed to a post, a watertight panel must be fixed behind the control box (350x400 mm minimum).
- Fix the support solidly to the wall or the watertight panel, and place the power pack on it using the screws provided.

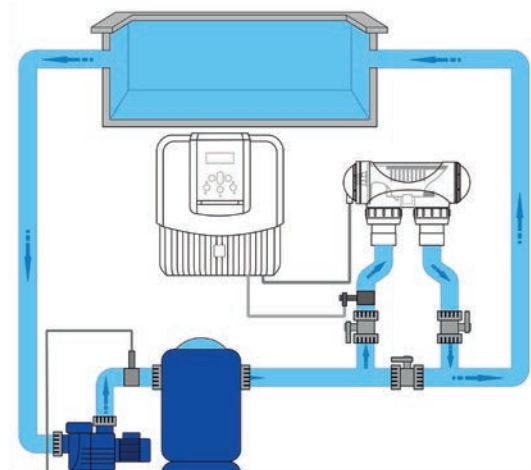

2.3 Installing the cell

- The cell must be installed on the piping after the filtering, after any measurement sensors, and after eventual heating systems.
- Ideally the water should flow from the electric connections towards the opposite side.
- Use the screw-on fittings to fix the cell to the pipes.
- For Ø63 mm pipes, glue them directly to the screw-on fittings (use a glue suitable for plumbing applications : compatible with ABS and PVC material). For Ø50 mm pipes, use glue-on PVC adapters of the corresponding diameter (grey models; the white models are for 1 ½'' UK pipes).
- Connect the cell power supply cable following the wire colour codes (red, black and blue connectors) and then refit the protective cap.



- **The cell must be installed horizontally to ensure proper operation and to avoid gas build up which can lead to equipment damage or serious injury.**
- **The cell must always be the last element placed on the pool return pipe (see diagram).**
- **It is always recommended to install the cell on a by-pass. This assembly is MANDATORY if the flow is in excess of 18 m³/hour to avoid load loss.**
- **If you install the cell on a by-pass, it is recommended to fit a check valve downstream from the cell instead of a manual valve, to avoid the risk of an improper setting which could result in the incorrect flow water back into the cell.**
- **The two red wires can be connected to one or the other red terminals on the electrode.**

2.4 Installing the flow controller

The flow controller and its fixture collar (Ø50 mm) must be installed on the piping close to the cell and upstream from it. Use the supplied threaded adapter and Teflon tape to install the flow controller on its fixture collar.

- Cell installed on a by-pass: the flow controller must be installed on the cell by-pass between the upstream isolation valve and the cell itself.
- Cell installed in line: the flow controller must be installed just in front of the cell and after a possible valve.
- Tighten the flow controller using the tightening nut only (tighten by hand!).

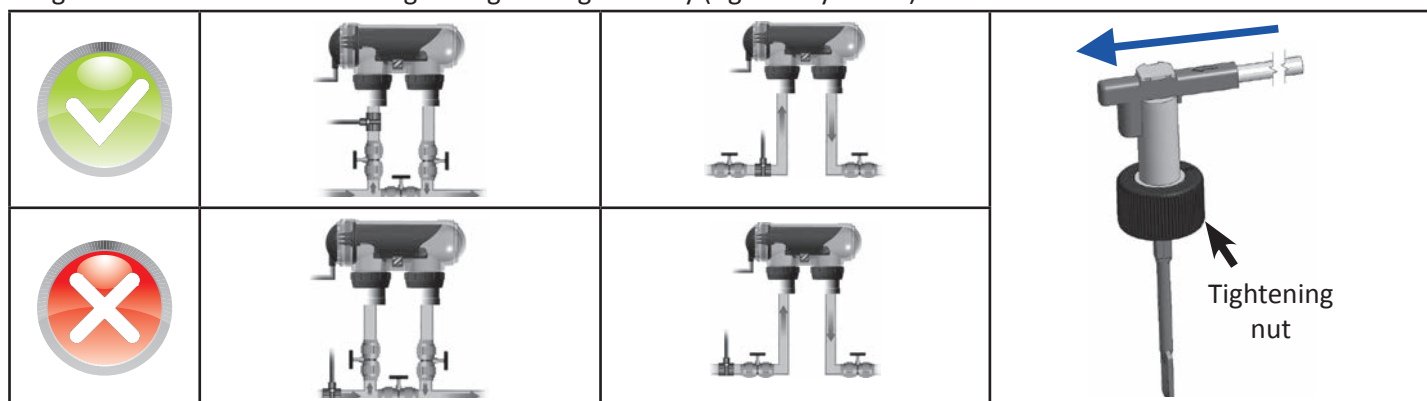

EN

- Failure to follow these instructions could lead to the destruction of the cell ! (see “2.3 Installing the cell”). The manufacturer cannot be liable in this case.
- The flow detector has a direction for installation (arrow indicated on it showing the flow direction for the water). Make sure that it is correctly placed on its fixture collar so that it stops the chlorinator production when filtering is stopped (red “Flow” indicator on showing the absence of flow, see “5. Troubleshooting”).

2.5 Electric connections

2.5.1 Connecting the power pack

The chlorinator can be connected in several different ways. Be sure to comply with all applicable installation codes and standards in the country of installation.

- Preferred Connection: the appliance, including the provided flow controller, is connected to a permanent power supply, which is separate from the power supply controlling the filtration pump. The power supply for the appliance must be protected by a 30mA Residual Current Device (RCD) / Ground Fault Circuit Breaker, which is not provided with the appliance and must be sourced separately or provided by the installer.
- Possible connection: the appliance is connected directly with the pool filtration power circuit, thereby allowing power to be supplied to it only when the filtration pump is operating.
- When all connections have been completed and all glued assemblies have dried, reconnect the mains power supply to power on the appliance.

! Whichever connection is used, it is mandatory to programme the chlorinator operating times (called “Timers”) (see “3.2.2 Programming Menu (Timers)”).

2.5.2 Connection to an electric roll-on shutter

If the pool is fitted with an electric roll-on shutter, it can be connected to the chlorinator so that the chlorinator automatically adapts its disinfectant production when the shutter is closed (see "3.1.2 "Low" mode").

- Make sure that power to the appliance is disconnected at the supply source.
- Remove the silver protective cover (1).
- Remove the 4 lower module fixture screws and remove the module (2). The bottom of the electric board is now visible (called "PCB" on the diagrams below).
- If you have a water balance regulation module, follow the installation steps to reassemble the module (see the module's installation and user manual).

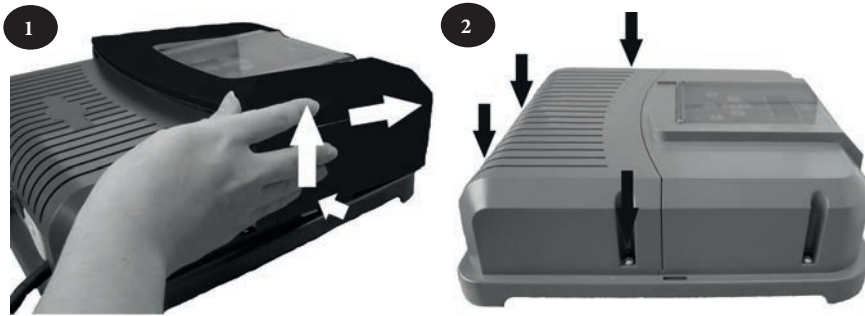

i The chlorinator is compatible with several different types of electric shutter. However, certain systems may not be compatible. In those cases activate the "Low" mode manually using its specific button on the chlorinator control panel (see "3.1.2 "Low" mode").

(1) = cell power supply	
(2) = flow controller	
(3) = shutter connection	
(4) = shunt	
(5) = ventilator	
(6) = 230V - 50Hz power supply	

Shutter with an end of run dry contact (1):

(shutter closed = contact closed)

Shunt the left hand "R/W" and "+15V" terminals, then connect the dry contact from the shutter to the "BLK" and "0V" terminals (3).

Shutter sending a closure signal (2):

(shutter closed = LV 12-24 V dc)

Connect the casing to the "BLK" terminal" and the positive (12-24 Vdc) to the left "R/W" terminal (3).

2.5.3 Connection of an external controller (Automation)

The chlorinator is compatible with certain types of remote control for pools (“automation”). It has especially been designed to operate on the Zodiac AquaLink TRI® system.



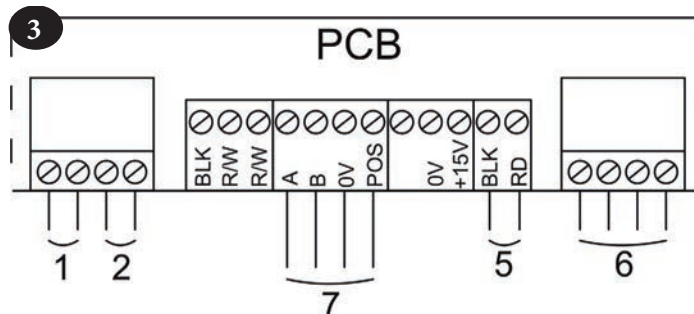

- Make sure that power to the appliance is disconnected at the supply source.
- Remove the protective cover and the lower module (see “2.5.2 Connection to an electric roll-on shutter”). If the appliance is already fitted with a water balance regulation module, carefully disconnect its connection braid before removing the module.
- Remove the small white cap covering the hole designed to pass the “RS485” type connection cable (available as an accessory) between the chlorinator and the automation system.
- Pass the “RS485” cable from the automation system through the hole. Place a cable tie on the controller wire to prevent it from being pulled off.
- Wind the «RS485» cable three times around a ferrite (not supplied).
- Depending on the brand and type of external automation system, complete the following connections for the connection cable (7, 3):

	Zodiac® AquaLink® TRI, Jandy AquaLink® et Polaris EOS :	Pentair® Intellitouch :
A Terminal	black wire	yellow wire
B Terminal	yellow wire	green wire
0V Terminal	green wire	black wire
POS Terminal	red wire	red wire











- Close the chlorinator control box cover.
- Make sure the automation system is switched off, then power on the chlorinator.
- Go to the “CONTROLLER” menu on the chlorinator and select the corresponding model from the list (see “3.2.4 External controller menu (Automation)”). The default setting is “AQUALINK TRI”
- Switch on the automation system and wait for a few seconds.
- If the connection is successful the “‡” symbol will appear in the top right corner of the chlorinator screen:



- If the connection fails, switch off both the automation system and the chlorinator, check all the electric connections and repeat the test. It may be necessary to reinitialize the chlorinator. To do this press on  and  simultaneously: the appliance will restart and the clock we have to be reset to the correct time. Consult the automation system user manual if necessary.
- Once the chlorinator is connected to an automation system it will only be possible to access its menu via its control panel. The modification of all disinfectant production related settings will from now on be managed using the automation system user interfaces.

3. Use

3.1 User interface presentation

TRi	TRi Expert	
		Access the user menu or return
		From the home screen: increase or reduction in disinfectant production. On the user menu: navigation in the menu options and value changes when a choice is proposed.
		Validate a selection or access a sub-menu
		Start or stop disinfectant production
		Activate super-chlorination for a total period of 24 hours (blue indicator on)
		Blocks disinfectant production at 10% (blue indicator on)
FLOW		Red indicator showing the absence of flow
POWER		Blue indicator showing disinfectant production (flashes if an error message is displayed, see "5. Troubleshooting")
SALT	SALTS	Orange indicator showing a water conductivity problem (not enough salt, water too cold, etc.)

 If the language displayed on the screen when the chlorinator is first powered is not appropriate, see "3.2.5 Language Menu".

3.1.1 "Boost" mode

In certain cases your pool may need higher than normal chlorination (stormy weather, high number of bathers, etc.). The "Boost" mode is used to quickly increase disinfectant levels.

- Press the  button: "BOOST" is displayed on the screen and 100% disinfectant production starts.

- When "Boost" mode is activated, the electrolyser operates at a 100% disinfectant production level for a total 24 hours. The number of days will therefore depend on the filtration operating times. The appliance's operating times (see "«3.2.2 Programming Menu (Timers)»") are temporarily ignored for the duration of the Boost mode.

 The "Boost" mode cannot be started or stopped in the following conditions:



- if the chlorinator is stopped,
- if the chlorinator is connected to an automation system (the "Boost" mode is then driven from the automation system user interface).

3.1.2 “Low” mode

If your pool has a covering system (shelter, shutter, cover, etc.), “Low” mode is designed to adapt disinfectant production to situations where the pool is covered (lower needs).

This mode is also called “Shutter” or “Winter” mode. Its effect is to limit disinfectant production to 10%.

Manual activation (shelter, cover, winter use, etc.):

- Press the  button: “LOW MODE 10%” is displayed on the screen and disinfectant production is reduced to 10%.
- To stop this mode: press the  button again.

Automatic activation (compatible electric roll-on cover):

- Make sure the cover is compatible and connected to the chlorinator (see “2.5.2 Connection to an electric roll-on shutter”).
- “Low” mode will automatically be activated when the shutter is closed.
- “Low” mode will stop as soon as the cover is completely open (after a timer of a few minutes).

“Low” mode cannot be started or stopped in the following conditions:











- if the chlorinator is stopped,
- if the chlorinator is connected to an automation system but is not connected to a roll-on shutter (“Low” mode is then driven from the automation system user interface).

3.2 Settings

3.2.1 Clock Menu

 The chlorinator is fitted with an internal memory. When the appliance is first switched on it is important to leave it powered on continuously for at least 24 hours in order to initially charge the accumulator (permanent separate power supply or filtering on permanently). Once loaded the accumulator has several weeks of autonomy in the event of a power failure.

- Power on the chlorinator and wait for the screen start-up sequence to complete.

- Press the  button to access the main menu.
- Use the  and  buttons to reach the “CLOCK” line and press  to validate.
- Use the  and  buttons to set the hour, then press  to memorise.
- Use the  and  buttons to set the minutes, then press  to memorise. The chlorinator will then automatically return to the main menu.
- Press the  button to return to the home screen.

 The time is displayed in a 24 hour format.



















3.2.2 Programming Menu (Timers)

 The chlorinator has two programmers to control disinfectant production times. These are called “Timers or “Operating time intervals”.



- “Timer” programming is used to define the chlorinator operating times within the filtering system operation times. The daily operating times must be sufficient to correctly treat the water.
- A reminder of the calculation rule (with a single speed filtration pump) : the ideal daily filtering time is obtained by dividing the required pool water temperature (measured in °C) by 2. Example: for water at 28°C - 28/2 - 14 hours per day
- The chlorinator is fitted with a safety device to prevent disinfectant overproduction. It switches off the appliance after 30 hours of continuous disinfection (no «Timers(s)» memorised and filtering in continuous mode (manual mode)). Pressing the  button will restart production if necessary.







Creating a “Timer”:

- On the home screen press the  button.
- Use the  and  buttons to reach the “PROGRAMMING” line, then press  to display the programming settings menu.
- Use the  and  buttons to select the timer to set (“TIMER 1” or “TIMER 2”), then press .
- Use the  and  buttons to set the starting time hour, then press  to memorise.
- Use the  and  buttons to set the starting time minutes, then press  to memorise.
- Use the  and  buttons to set the stopping time hour, then press  to memorise.
- Use the  and  buttons to set the stopping time minutes, then press  to memorise. The chlorinator returns to the “PROGRAMMING” menu automatically.
- The “T” symbol is displayed in the upper right hand corner of the LCD display on the home screen if the programming is valid :











15:31 ON T
PRODUCTION 60%

Deleting a “Timer”:

- On the home screen press the  button.
- Use the  and  buttons to reach the “PROGRAMMING” line, then press  to display the programming settings menu.
- Use the  and  buttons to reach “RAZ TIMERS”, then press . A message confirming the deletion will be shown on the screen.









3.2.3 Troubleshooting menu

 The chlorinator automatically notifies you of any problems using error messages. To help with the understanding of these messages the appliance has a troubleshooting assistance menu which gives the meanings and the action to take to solve the problem.

- On the home screen press the  button.
- Use the  and  buttons to reach the “TROUBLESHOOTING” line, then press  to display the list of error messages.
- Use the  and  buttons to select the error message, then press .
- A certain number of suggestions and solutions will automatically be scrolled to explain what to do. Once the automatic scrolling is complete, the chlorinator automatically returns to the “TROUBLESHOOTING” menu.

3.2.4 External controller menu (Automation)

 The automation system must imperatively have its settings positioned before the connection becomes active (external controller switched off, see “2.5.2 Connection to an electric roll-on shutter”).

- On the home screen press the  button.
- Use the  and  buttons to reach the “EXTERNAL CONTROLLER” line, then press  to display the different models.
- Use the  and  buttons to select the version of the external controller used, then press  to memorise the choice. The chlorinator will then automatically return to the main menu.
- Press the  button to return to the home screen.
- Switch on the automation system and wait for the “‡” symbol to appear in the top right hand corner of the chlorinator home screen, meaning that the connection was successful :









15:31 ON ‡
PRODUCTION 60%

 By default the chlorinator is set to be connected to a Zodiac Aqualink TRi® system.

3.2.5 Language Menu

 By default the chlorinator is set to display in French. Seven languages are available: English, French, Spanish, German, Italian and Dutch.

- On the home screen press the  button.
- Use the  and  buttons to reach the “LANGUAGES” line, then press  to display the list of languages.
- Use the  and  buttons to select the required language, then press  to memorise the choice. The chlorinator will then automatically return to the main menu.

4. Maintenance

4.1 Cleaning the electrode

 The chlorinator is equipped with a smart polarity inversion system designed to prevent the electrode plates from scaling. However cleaning may be required in regions where the water is very hard.

- Turn off the chlorinator and the filtering, close the isolation valves, remove the protection cover and disconnect the cell power cable.
- Unscrew the tightening ring and remove the electrode from the body of the cell. The ring is notched thus allowing a lever to be used in the event of it jamming. Place the electrode in a cleaning solution without immersing the connection terminals.
- Leave the cleaning solution to dissolve the scale deposit for about 15 minutes. Dispose of the cleaning solution at an approved waste recycling site, never pour into the rainwater drainage system or into the sewers.
- Rinse the electrode using clean water and refit it into the body of the cell (there is a fail-safe on the alignment).
- Refit the tightening ring, reconnect the cell cable and refit the protective cover. Open the isolation valves and restart the filtering and chlorinator.



- If you do not use a commercially available cleaning solution, you can manufacture it yourself by carefully mixing 1 volume of hydrochloric acid with 9 volumes of water (Warning: always pour the acid into the water and not the opposite and wear suitable protective equipment!).
- If the water is too hard (high carbonate content, HL>40 °f or 400 ppm), it is possible to change the polarity inversion cycle times on your chlorinator to have more effective electrode self-cleaning. Consult your reseller if you are in this situation (professional access).

4.2 Winterizing

 The chlorinator has a protective system to limit disinfectant production under bad operating conditions such as cold water (winter) or a lack of salt.

- Active winterizing = filtering operational in winter: below 10°C it is preferable to switch off the chlorinator. Above this temperature you can leave it running.
- Passive winterizing = lower water level and drained piping: leave the electrode dry in its cell with its isolation valves open.

5. Troubleshooting



- Before you contact your reseller, please carry out these few simple checks using the following table if a problem occurs.
- If the problem continues contact your reseller.
- : Actions reserved for a qualified technician

Message	Possible causes	Solutions
CHECK SALT (orange “SALT” indicator on)	<ul style="list-style-type: none"> • Pool water temperature too low (< 18 °C, variable). • Lack of salt (< 4g/L or 2.2 g/L in accordance with the model) due to water loss or dilution (filter counterwash, water renewal, rain, leaks, etc.). • Can vary depending on the temperature and age of the cell. The voltage across the cell terminals varies in time. 	<ul style="list-style-type: none"> • Basic production limitation signal when the water is too cold. Reduce disinfectant production or add salt to compensate. • Add salt to the pool to keep the level at 4 g/l or 2,2 g/L in accordance with the model : see “1.2 Technical specifications”. If you do not know the salt level or how to test it, consult your reseller.
CHECK CELL	<ul style="list-style-type: none"> • Calcium carbonate level (HL) too high • Electrode too old • Scaled cell 	<ul style="list-style-type: none"> • Clean and/or check the filtering system (pump and filter) • Check the calcium carbonate levels (HL) and add calcium carbonate sequestrant if necessary (Calci-) • Replace the electrode : • Clean the cell
PUMP FLOW CONTROLLER FAULT (“Flow” indicator red and lit) The messages are displayed alternatively every 3 minutes.	<ul style="list-style-type: none"> • Failure of the filtering pump • The filter and/or the skimmer(s) are dirty • By-pass valves closed • Flow controller and/or cell disconnected or defective 	<ul style="list-style-type: none"> • Check the pump, the filter, the skimmer(s), and the by-pass valves. Clean them if necessary • Check the cable connections (cell and flow controller) • Check that the flow controller is working correctly (replace it if necessary :)
PROD. FAULT	<ul style="list-style-type: none"> • Cell power supply cable disconnected or not properly connected • Internal electronic problem in the control box following an external electric incident 	<ul style="list-style-type: none"> • Switch off the chlorinator (button) and switch off the power supply to the control box, then check that all the cables are properly connected (mains power supply, cell, etc.)
INVERSION	<ul style="list-style-type: none"> • The self-cleaning cycle is automatic; this message is not an error code but an information message 	<ul style="list-style-type: none"> • Wait for about 10 minutes and disinfectant production will resume automatically at the previously set level

If the problem continues contact your reseller



To cancel the “CHECK CELL” and “PROD. FAULT” error messages, press for 3 or 4 seconds on when the message appears.
The other codes are only information messages that disappear automatically when the operating conditions return to optimal.

Votre revendeur
Your retailer

Modèle appareil
Appliance model

Numéro de série
Serial number

Trouvez plus d'informations et enregistrez votre produit sur
More informations and register you product on

www.zodiac.com

