

# Z550iQ

*i*AquaLink™  
CONTROL

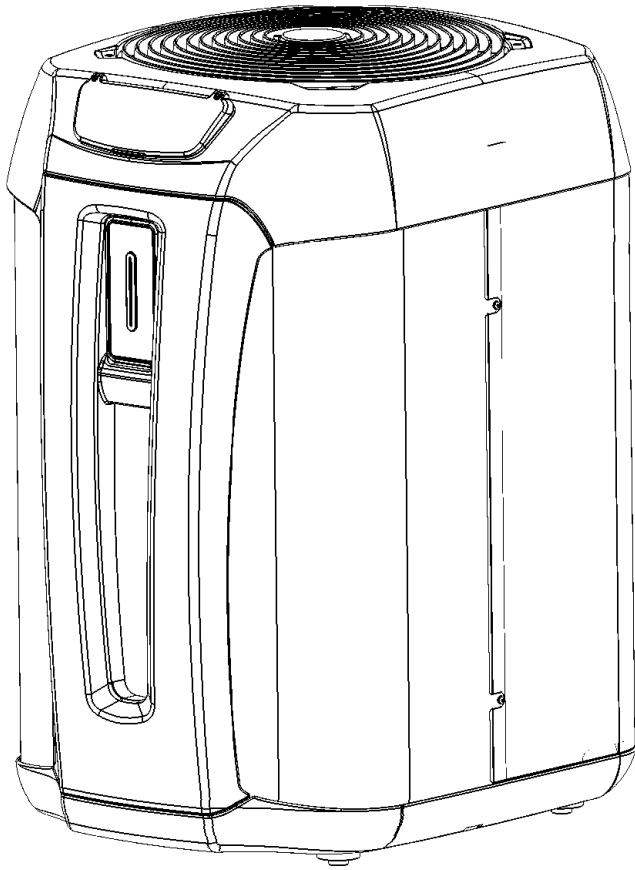

Instructions for installation and use - English  
Heat pump  
Translation of the original instructions in French

EN

More documents on:  
[www.zodiac.com](http://www.zodiac.com)

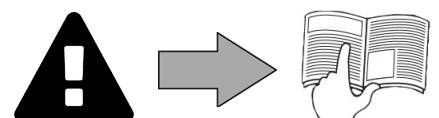



## WARNINGS



**Carefully read the instructions in this manual before using the unit.**

- Before handling the appliance, it is vital that you read this installation and user manual, as well as the "Warranties" booklet delivered with the appliance. Failure to do so may result in material damage or serious or fatal injury and will void the warranty.
- Keep and pass on these documents for later viewing throughout the appliance's service life.
- The distribution or modification of this document in any way is prohibited, without prior authorisation from the manufacturer.
- The manufacturer is constantly developing its products to improve their quality. The information contained herein may therefore be modified without notice.

### **GENERAL WARNINGS**

- Failure to respect the warnings may cause serious damage to the pool equipment or cause serious injury, even death.
- Only a person qualified in the technical fields concerned (electricity, hydraulics or refrigeration) is authorised to carry out maintenance or repair work on the appliance. The qualified technician working on the appliance must use/wear personal protective equipment (such as safety goggles and protective gloves, etc.) in order to reduce the risk of injury occurring when working on the appliance.  
- Before handling the appliance, check that it is switched off and isolated.
- The appliance is intended to be used for pools and spas for a specific purpose; it must not be used for any purpose other than that for which it was designed.
- This appliance is not intended for use by individuals (including children) with impaired physical, sensorial or mental abilities, or persons lacking in knowledge and experience, unless they receive supervision or prior instructions on using the appliance from a person responsible for their safety.
- Children must be supervised to ensure that they do not play with the appliance.
- This appliance can be used by children over 8 and adults with impaired physical, sensory or mental capabilities, or who lack experience and knowledge, if they are correctly supervised or have been instructed in how to use the appliance safely and understand the hazards involved.
- This appliance should not be cleaned or maintained by children without supervision.
- The appliance must be installed according to the manufacturer's instructions and in compliance with local and national standards.
- The installer is responsible for installing the appliance and for compliance with national installation regulations. Under no circumstances may the manufacturer be held liable in the event of failure to comply with applicable local installation standards.
- For any work other than the simple user maintenance described in this manual, the product should be referred to a qualified professional.
- If the appliance suffers a malfunction, do not try to repair it yourself; instead contact a qualified technician.
- Refer to the warranty conditions for details of the permitted water balance values for operating the appliance.
- Deactivating, eliminating or by-passing any of the safety mechanisms integrated into the appliance shall automatically void the warranty, in addition to the use of spare parts manufactured by unauthorised third-party manufacturers.
- Do not spray insecticide or any other chemical (inflammable or non-inflammable) in the direction of the appliance, as this may damage the body and cause a fire.
- Do not touch the fan or moving parts and do not place objects or your fingers in the

vicinity of the moving parts when the appliance is in operation. Moving parts can cause serious injury or even death.

### **WARNINGS ASSOCIATED WITH ELECTRICAL APPLIANCES**

- The power supply to the appliance must be protected by a dedicated 30 mA Residual Current Device (RCD), complying with the standards and regulations in force in the country in which it is installed.
- Do not use any extension lead when connecting the appliance; connect the appliance directly to a suitable power supply.
- Before carrying out any operations, check that:
  - The required input voltage indicated on the appliance information plate corresponds to the mains voltage;
  - The mains supply is compatible with the appliance's electricity needs and is correctly grounded.
- In the event of abnormal operation or the release of odours from the appliance, turn it off immediately, unplug it from its power supply and contact a professional.
- Before servicing or performing maintenance on the appliance, check that it is powered off and completely disconnected from the power supply. Moreover, check that the heating priority (where applicable) is deactivated and that any other device or accessory connected to the appliance is also disconnected from the power supply.
- Do not disconnect and reconnect the appliance to the power supply when in operation.
- Do not pull on the power cord to disconnect it from the power supply.
- If the power cord is damaged, it must be replaced by the manufacturer, an authorised representative or a repair facility only.
- Do not perform maintenance or servicing operations on the appliance with wet hands or if the appliance is wet.
- Before connecting the appliance to the power supply, check that the connection unit or socket to which the appliance will be connected is in good condition and shows no signs of damage or rust.
- For any component or sub-assembly containing a battery: do not recharge or dismantle the battery, or throw it into a fire. Do not expose it to high temperatures or direct sunlight.
- In stormy weather, disconnect the appliance from the power supply to prevent it from suffering lightning damage.
- Do not immerse the appliance in water (with the exception of cleaners) or mud.

### **WARNINGS CONCERNING APPLIANCES CONTAINING R410A REFRIGERANT**

- Do not discharge R410A fluid into the atmosphere. This is a fluorinated greenhouse gas, covered by the Kyoto Protocol, with a Global Warming Potential (GWP) = 2088 (European regulation EU 517/2014).
- In order to comply with the applicable standards and regulations in terms of the environment and installation, in particular Decree No. 2015-1790 and/or European regulation EU 517/2014, a leak test must be performed on the cooling circuit when the appliance is first started and at least once a year. This operation must be carried out by a specialist certified to test cooling appliances.

### **INSTALLATION AND MAINTENANCE**

- The appliance may not be installed close to combustible materials, or the air duct inlet of an adjacent building.
- With some appliances, it is essential to fit a "protection grid"-type accessory if the unit is installed in an area with uncontrolled access.
- During installation, troubleshooting and maintenance, pipes may not be used as steps: the pipe could break under the weight, spilling coolant and possibly causing serious burns.
- When servicing the appliance, the composition and state of the heat transfer fluid must be checked, as well as the absence of any traces of coolant.

- During the appliance's annual sealing test in accordance with applicable legislation, the high and low pressure switches must be checked to ensure that they are securely fastened to the cooling circuit and that they cut off the electrical circuit when tripped.
- During maintenance work, ensure there are no traces of corrosion or oil around the cooling components.
- Before beginning work on the cooling circuit, stop the appliance and wait for a few minutes before fitting the temperature and pressure sensors. Some elements such as the compressor and piping may reach temperatures in excess of 100°C and high pressures with the consequent risk of severe burns.

### **TROUBLESHOOTING**

- All brazing must be carried out by qualified brazers.
- Replacement pipes must always be made of copper in compliance with standard NF EN 12735-1.
- Leak detection; pressure test:
  - never use oxygen or dry air (risk of fire or explosion)
  - use dry nitrogen or the mixture of nitrogen and refrigerant indicated on the information plate,
  - the test pressure for both the high and low pressure circuits must not exceed 42 bar (for R410A) in cases where the appliance is equipped with the optional pressure gauge.
- The high pressure circuit pipes are made of copper and have a diameter equal to or greater than 1''5/8. A certificate as indicated in §2.1 in compliance with standard NF EN 10204 must be requested from the supplier and filed in the installation's technical file.
- Technical data relative to the safety requirements of the various applicable directives are indicated on the information plate. All this information must be recorded in the appliance's installation manual, which must be kept in its technical file: model, code, serial number, maximum and minimum OT, OP, year of manufacture, CE marking, manufacturer's address, coolant and weight, electrical parameters, thermo-dynamic and acoustic performance.

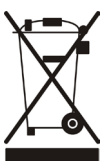

#### **Recycling**

This symbol is required by the European directive DEEE 2012/19/EU (directive on waste electrical and electronic equipment) and means that your appliance must not be thrown into a normal bin. It will be selectively collected for the purpose of reuse, recycling or creating value. If it contains any substances that may be harmful to the environment, these will be eliminated or neutralised. Contact your retailer for recycling information.

# CONTENTS



## 1 Installation

5

1.1 | Selecting the location

5

1.2 | Hydraulic connections

6

1.3 | Electricity supply connections

7

1.4 | Option connections

8



## 2 Use

10

2.1 | Operating principle

10

2.2 | User interface presentation

10

2.3 | Operation

12

2.4 | User functions

13

2.5 | Connecting to the iAquaLink™ app

16



## 3 Maintenance

17

3.1 | Winterising

17

3.2 | Maintenance

17



## 4 Troubleshooting

18

4.1 | Appliance behaviour

18

4.2 | Error code display

19

4.3 | Lighting of LEDs on the printed circuit board

20

4.4 | Wiring diagrams

21



## 5 Characteristics

24

5.1 | Description

24

5.2 | Technical data

25

5.3 | Dimensions and marking

26

EN



### **Tip: to make it easier to contact your retailer**

- Write down the retailer's contact details to help you find them more easily and fill in the "product" information on the back of the manual: the retailer will ask for this information.



# 1 Installation

## ➤ 1.1 | Selecting the location



- When the appliance is installed and protected by a residual current device (RCD) with a maximum amperage of 30 mA, it should be installed at a distance of at least 2 metres from the edge of the pool.
- Do not lift the appliance by the body; use its base.

- For outdoor installation, provide free space around it (see § "1.2 | Hydraulic connections").
- For indoor installation, the appliance must be equipped with the technical room kit.
- Place the appliance on its anti-vibration studs (integrated under its base, height adjustable) on a stable, solid and level surface.
- This surface must be able to bear the weight of the appliance (in particular in the case of installation on a roof, a balcony or any other support).

The appliance must not be installed:

- With the blowing towards a permanent or temporary obstacle (awning, brushwood, etc.) less than 5 metres away,
- on brackets,
- Within range of water or mud jets, sprays or run-off (take the effect of the wind into account),
- Near a heat source or flammable gas,
- Near high-frequency equipment,
- In a location where it would be subject to snow build-up,
- In a location where it might be flooded by the condensates produced by the appliance when operating.

### **Tip: to reduce noise produced by your heat pump**



- Do not install it under or facing a window.
- Do not tilt it towards your neighbours.
- Install the appliance in an open space (sound waves are reflected on surfaces).
- Install an acoustic screen around the heat pump, respecting the distances.
- Install 50cm of flexible PVC pipe at the heat pump water inlet and outlet (to stop vibrations).
- "ECOSILENCE" mode reduces the sound level and improves the appliance's COP. However, we recommend using this mode simply to "maintain temperature" and increasing the filtration time by about 50%.

## ➤ 1.2 | Hydraulic connections

- The device will be connected with a Ø50 PVC pipe, using the half union connectors supplied (see § “5.1 | Description”), to the pool's filtration circuit, after the filter and before the water treatment.
- Respect the direction of hydraulic connection.
- A by-pass must be installed to make it easier to work on the appliance.

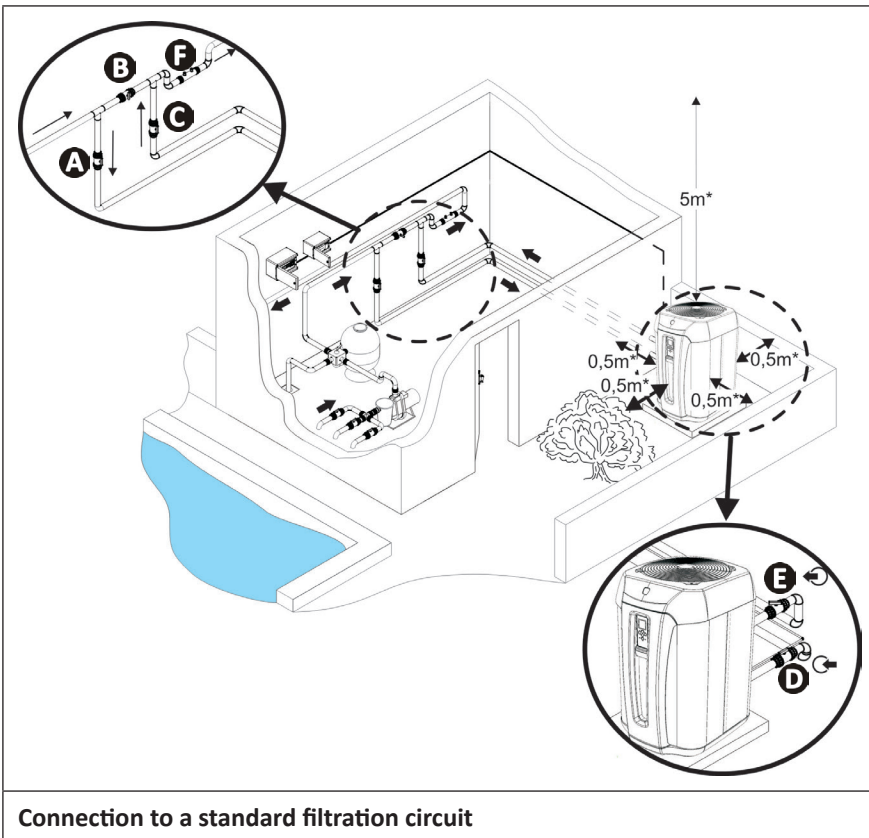

- To evacuate the condensates, fit a Ø18 pipe on the grooved elbow to be mounted under the appliance base.

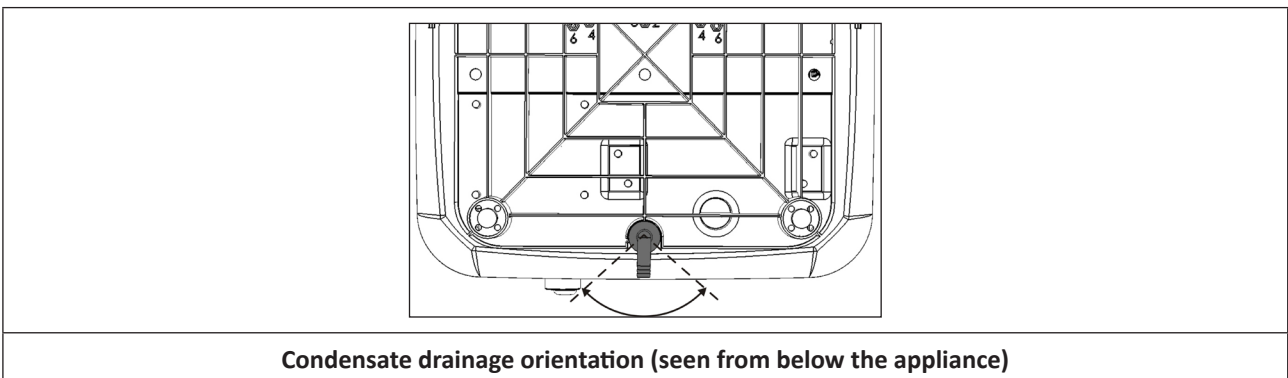

### **Tip: condensate drainage**

- Caution, several litres of water can be drained from your appliance each day. We strongly recommend connecting the drain to a suitable water drainage system.
- We also recommend tilting the appliance slightly backwards (using the adjustable studs) for better condensate drainage.

### ➤ 1.3 | Electricity supply connections



- Before any work inside the appliance, you must cut the electricity supply as there is a risk of electric shock which may cause material damage, serious injury or even death.
- Only a qualified and experienced technician is authorised to carry out cabling work within the appliance or to replace the power cord.
- Poorly tightened cabling terminals can cause the cables to overheat at the terminals and create a fire risk. Make sure that the terminal screws are fully tightened. Incorrectly tightened terminal screws will cancel the warranty.
- Do not disconnect the electricity supply when the appliance is running. If the electric power supply is interrupted, wait a minute before restoring the power.
- Means for disconnecting from the mains supply for all poles guaranteeing full disconnection in the over-voltage category III must be compliant and incorporated into the wiring.

- To access the electrical connection terminal boards:

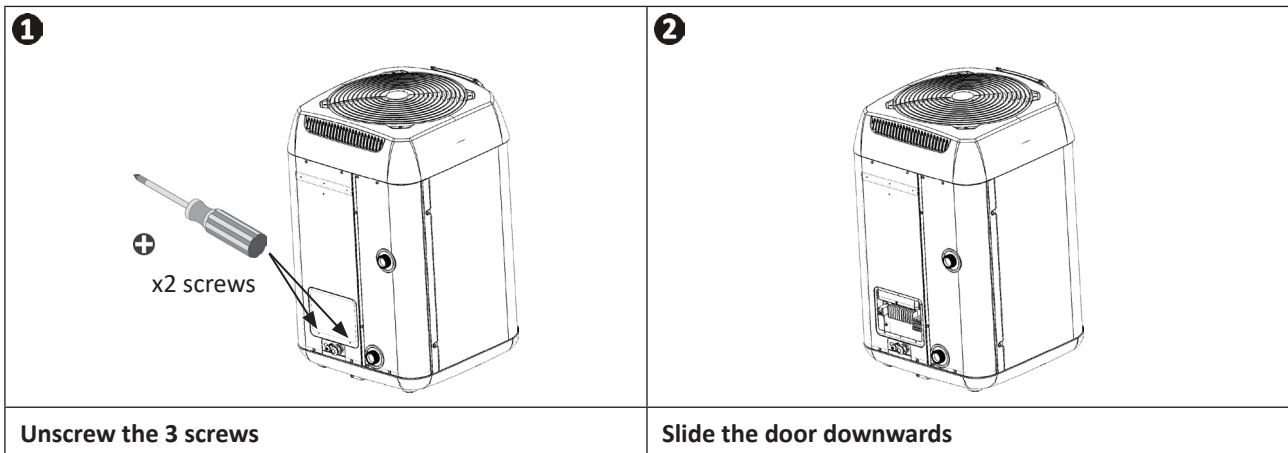

- The heat pump's electrical supply must be provided through a protection and circuit breaking device (not supplied) complying with the standards and regulations in force in the country where it is installed.
- The appliance is provided for connection to a general power supply with a TT and TN.S neutral regime.
- Electrical protection: by circuit breaker (C or D curve) (for rating, see § "5.2 | Technical data"), with a 30 mA dedicated residual-current protection system (circuit breaker or switch).
- Additional protection may be required during installation to guarantee the overvoltage category II.
- The power supply must correspond to the voltage indicated on the appliance's information plate.
- The power cord must be insulated against any cutting or hot elements that may damage or crush it.
- The appliance must be correctly connected to a suitable earth/ground circuit.
- The electrical connection lines must be fixed.
- Use the gland to pass the power cord into the appliance.
- Use the power cord (H07RN-F type) adapted for outdoor or buried use (or run the cable into a protection duct) with an external diameter of between 13 and 18mm.
- We recommend burying the cable at a depth of 50 cm (85 cm under a road or path) in an electrical duct (red ribbed).
- If this buried cable meets another cable or pipe (gas, water, etc.), there must be more than 20 cm between them.
- Connect the power supply cord to the spring-cage terminal block inside the appliance (see § "1.3.1 | Wiring on a spring-cage terminal block").



**Information: three-phase model terminal boards**

- On three phase models, there is no live order to be respected.



### 1.3.1 Wiring on a spring-cage terminal block

- Pull the lever up as far as it will go, then connect the cable (see figure 1).
- Return the lever back to its initial position (see image 2).

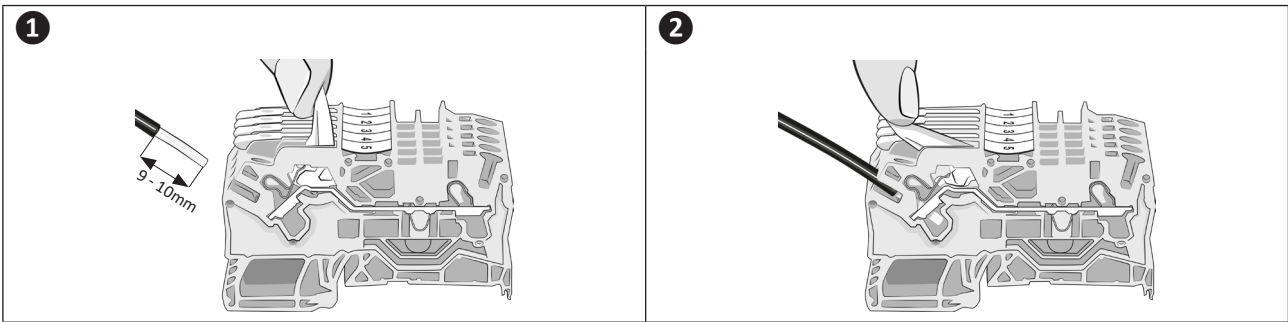

## 1.4 | Option connections

EN

### Connecting the "Heating priority" and "Remote "On/off" control" options:



- Before any work inside the appliance, you must cut the appliance's electricity supply as there is a risk of electric shock which may cause material damage, serious injury or even death.
- Any incorrect connection to terminals 1 to 6 may damage the appliance and cancel its warranty.
- Under no circumstances should the filtration pump motor be supplied via terminals 5 - 6.
- When intervening on terminals 1 to 6, there is a risk of electrical return current, injuries, material damage and death.
- Use cables with a section of at least  $2 \times 0.75 \text{mm}^2$ , H07RN-F type and with a diameter between 8 and 13mm.
- Use the gland to pass the cables into the appliance. The cables used for the options and the power cord must be kept separate (risk of interference) using a collar inside the appliance just after the glands.

#### 1.4.1 "Heating priority" option

- This function allows the appliance to start filtration (in 5-minute cycles every 120 minutes) in order to detect the water temperature and thus activate the filtration + heating unit to maintain a constant water temperature. The filter pump is thus said to be slaved to the heating system. Filtration is kept in operation or activated if the pool temperature falls below the desired temperature.
- For the connection, connect the filtration timer to terminals 1 - 2 (dry contact, no polarity, maximum intensity 8A).
- The "Heating priority" function is activated by default; to deactivate it, set the P50 parameter to "ON".

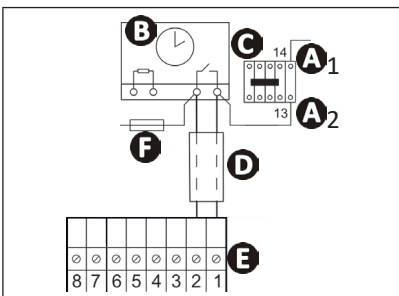

- A1- A2:** power for the filtration pump power contactor coil
- B:** filtration timer
- C:** power contactor (tripolar or bipolar) for the filtration system pump motor
- D:** separate cable for the "heating priority" function (not supplied)
- E:** heat pump terminal board
- F:** fuse

### 1.4.2 "Remote "On/Off" control" option

- This option allows the "remote On/Off" function to be enabled by way of a switch installed remotely.
- To connect, couple the remote "On/Off" switch (not provided) to terminals 3 - 4 (dry contact).

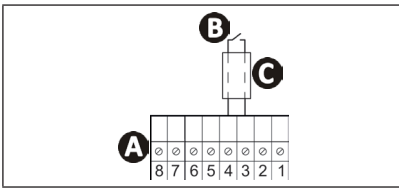

- A:** heat pump terminal board
- B:** remote "on/off" switch (not supplied)
- C:** separate connection cable (not supplied)

- When the contact 3 - 4 is open:
  - The device cannot be started in any way.
  - The "OFF" message (see image 1) alternates with the current display: the measured water temperature (see image 2) if the device is on, or "---" (see image 3) if the device is switched off.
  - On the LED strip lights, LED 1 (see § "2.2.2 LED strip") remains lit (green if operating in "Heating" mode, blue if operating in "Cooling" mode) with 50% brightness.

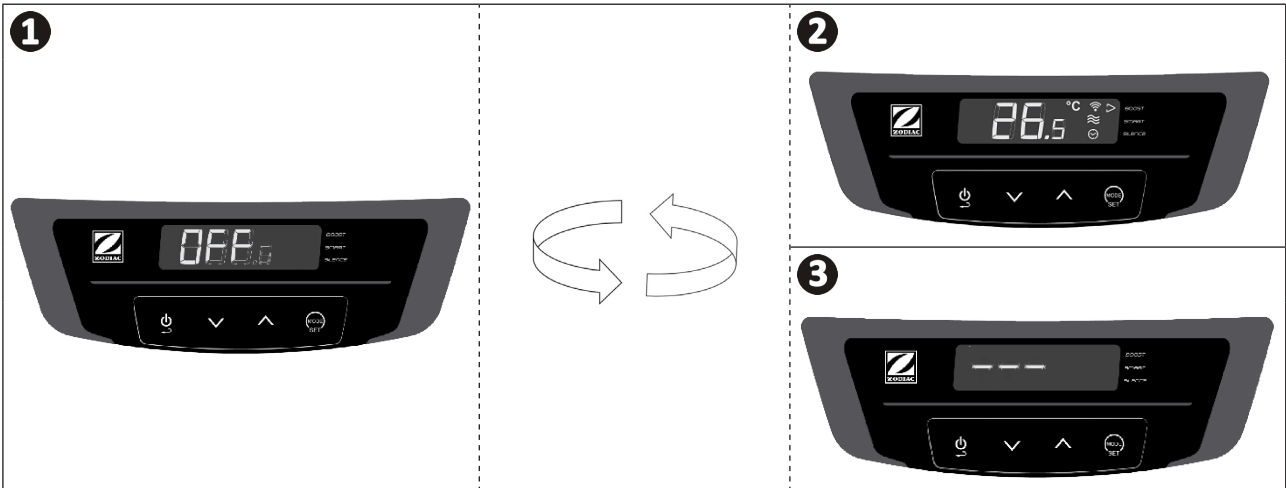



## 2 Use

### 2.1 | Operating principle

The heat pump uses the calories (heat) in the air to heat up your pool's water. The process to heat your pool's water to the temperature you want may take a few days as it depends on the weather conditions, the heat pump's power and the difference between the water temperature and the temperature you want.

The heat pump is ideal for maintaining temperature.

The hotter and more humid the air, the better your heat pump will perform.



#### **Tip: to improve the heating and maintaining of your pool's temperature**

- Anticipate the commissioning of your pool far enough in advance before you use it.
- For the temperature rise, set the water circulation to continuous (24/24) in "Boost" mode.
- To maintain the temperature throughout the season, run "automatic" circulation for the equivalent of the water temperature divided by two (the longer this time, the more sufficient the operating range of the heat pump to heat the pool), in "SMART" or "ECOSILENCE" mode.
- Cover the pool with a sheet (bubble canopy, canvas, etc.) to prevent heat loss.
- Take advantage of a period with mild outdoor temperatures (on average > 10°C at night); it will be even more effective if it runs during the warmest hours of the day.
- Keep the evaporator clean.
- Set the temperature you want and let the heat pump run.
- Connect the "Heating priority"; the filtration pump and heat pump operating time will be set according to requirements.

EN

### 2.2 | User interface presentation

#### 2.2.1 Display screen and keyboard



Measured water temperature\*





\*Displays the temperature measured during the last operation of the heat pump.

|                  | Description | Steady                                      | Flashing                                    | Off                                       |
|------------------|-------------|---|---|---|
| Indicator lights |             | Keypad locked                               | /   | Keyboard unlocked                         |
|                  |             | Water flow okay                             | Water flow too low or missing               | /   |
|                  |             | Indicates the selected mode                 | /   | /   |
|                  |             | /   | Air temperature outside range of operation. | Air temperature inside range of operation |
|                  |             | Selected temperature unit                   | /   | /   |
|                  |             | Wi-Fi connected                             | Wi-Fi pairing in progress                   | Wi-Fi not connected                       |
| <b>Function</b>  |             |   |   |   |
| Keys             |             | "On/off" (press for 3 seconds) or back/exit |   |   |
|                  |             | Menu selection and access                   |   |   |
|                  |             | To browse and adjust the values             |   |   |

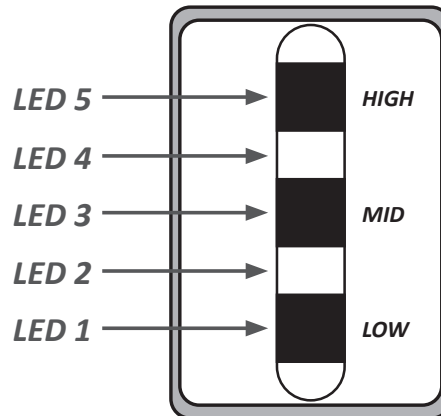
## 2.2.2 LED strip

The LED strip on the front of the appliance gives you a rapid overview of the heat pump's operating status. The following table explains the meaning of the different strip lights.



|                                 | Colour                              | LED(s) on                  | Brightness  | Meaning  |
|---------------------------------|-------------------------------------|----------------------------|---|--|
| LED strip                       | Steady lit green (= "Heating" mode) | 1* or 1 + 3* or 1 + 3 + 5* | 100 %   | The heat pump is heating the water.  |
|                                 |                                     | 1 + 3 + 5                  | 50 %  | Temperature set point reached.   |
|                                 |                                     | 1                          | 50 %  | Heat pump on standby for one of the following reasons (inherent to the machine's regulation in normal operation): <ul style="list-style-type: none"> <li>Compressor timer (anti-short-cycle protection)</li> <li>With  flashing = water flow too low or missing.</li> <li>With display of transitional "OFF" message = operation not authorised by the remote "On/Off" switch (see § "1.4.2 Remote "On/Off" option").</li> <li>With  flashing = external air temperature outside range of operation (-12°C ~ 40°C).</li> </ul>                               |
|                                 | Steady lit blue (= "Cooling" mode)  | 1                          | 100 %   | The heat pump is cooling the water.  |
|                                 |                                     | 1                          | 50 %  | Heat pump on standby for one of the following reasons (inherent to the machine's regulation in normal operation): <ul style="list-style-type: none"> <li>Compressor timer (anti-short-cycle)</li> <li>"Cooling" mode not activated.</li> <li>With  flashing = water flow too low or missing.</li> <li>With display of transitional "OFF" message = operation not authorised by the remote "On/Off" switch (see § "1.4.2 Remote "On/Off" option").</li> <li>With  flashing = external air temperature outside range of operation (10°C ~ 40°C).</li> </ul> |
| Steady lit red (= "Error" mode) | 1 + 3 + 5                           | 100 %                      | Error in progress => see error message on the screen (see § 4.2   "Error code display")   |  |
| Flashing red (= "Error" mode)   | 1 + 3 + 5                           | 100 %                      | Appliance stopped after more than 4 errors in one hour => requires manual restart after resolving the error (see § "4.2   Error code display"). |  |
|                                 | /                                   | /                          | /   | Appliance switched off or not connected to the power supply.   |

\* The number of LED(s) that are lit can vary depending on the selected active operating mode (see § "2.4.4 Using and selecting the different active operating modes").

### Information: appliance display powered and off



## ➤ 2.3 | Operation

- Check that there are no tools or other foreign objects in the machine.
- The panel that provides access to the technical section must be put in place.
- Set the valves as follows: valve B wide open, valves A, C, D and E closed

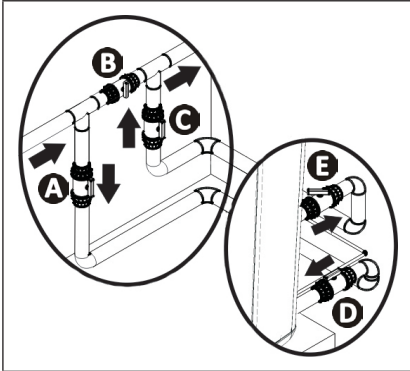

- A**: Water inlet valve
- B**: By-pass valve
- C**: Water outlet valve
- D**: Water inlet adjustment valve (optional)
- E**: Water outlet adjustment valve (optional)



- **An incorrect by-pass setting may cause the heat pump to malfunction.**

- Check that the hydraulic corrections are correctly tightened and that there are no leaks.
- Check that the appliance is stable.
- Set the water circulation running.
- Close valve B gradually so that the filter pressure is increased by 150g (0.150 bars).
- Open valves A, C and D fully then valve E by half (the air which has built up in the heat pump condenser and the filtration circuit will bleed out). If valves D and E are not present, open valve A wide and close valve C by half.
- Connect the power supply to the heat pump.
- If the heat pump is on standby, press  for 3 seconds; the splash screen appears for 4 seconds then the home screen is displayed. A 2-minute timer will start.
- Set the desired temperature (called the "setpoint", see § 2.4.2 "Adjusting the temperature setpoint").

After the start-up steps for your heat pump:



- Shut down the water circulation temporarily (by stopping the filtration or closing valve A or C) to check that your appliance stops after a few seconds (via the activation of the flow switch).
- Reduce the setpoint temperature to below the water temperature to check that the heat pump stops operating.
- Switch off the heat pump by pressing and holding  for 3 seconds and check that it stops.

## ➤ 2.4 | User functions









### 2.4.1 "Automatic keypad lock" function

The "automatic keypad lock" function allows the keypad to be disabled when inactive for at least 30 seconds (default value) to prevent mishandling.







#### Locking/unlocking the keypad:

- Press  and  simultaneously for 3 seconds. The  indicator appears (= locked) or disappears (= unlocked) depending on the keypad's state.

#### Enabling/disabling the "automatic keypad lock" function:

- From the main screen (where the measured water temperature is displayed), press and hold . "COOL" is displayed on the screen.
- Use the  or  keys to find the "P19" setting, then press  to confirm.
- Use the  or  keys to select either 0 or 1:
  - 0 = "automatic lock" function disabled.
  - 1 = "automatic lock" function enabled.
- Press  to confirm.
- Press  to go back to the previous screen. Press  several times to return to the main screen (where the measured water temperature is displayed).

### 2.4.2 Adjusting the temperature setpoint.

- From the main screen (where the measured water temperature is displayed), press and hold  or . The setpoint temperature is displayed and flashes on the screen.
- Press  to increase the temperature by 0.5°C,
- Press  to reduce the temperature by 0.5°C.
- Press  to confirm the setpoint temperature. However, when the keypad remains inactive for more than 3 seconds following the moment that the setpoint temperature has been modified, it is confirmed automatically, even if the  button has not been pressed. Once the setpoint temperature has been confirmed, the display automatically returns to the main screen (where the measured water temperature is displayed).



- When the setpoint temperature is reached (+ 0.5° C), the heat pump stops heating the water (LEDs 1, 3, and 5 green with 50% brightness, see § "2.2.2 LED strip").

### 2.4.3 Activating/deactivating the "Cooling" mode

#### Information: "Cooling" function

- Activating the "Cooling" mode allows the machine's cycle to be automatically reversed to cool the pool water.
- When the "Cooling" function is activated, as soon as the water temperature exceeds the setpoint temperature by more than 2°C (see following diagram), the heat pump automatically activates the "Cooling" function until the temperature setpoint is reached (+ 0.5°C).
- When the "Cooling" function is activated (+2°C above the setpoint temperature), the heat pump will automatically switch to "Cooling" mode (LED 1 lit in blue, see § "2.2.2 LED strip") until returning to the setpoint temperature (+ 0.5°C).

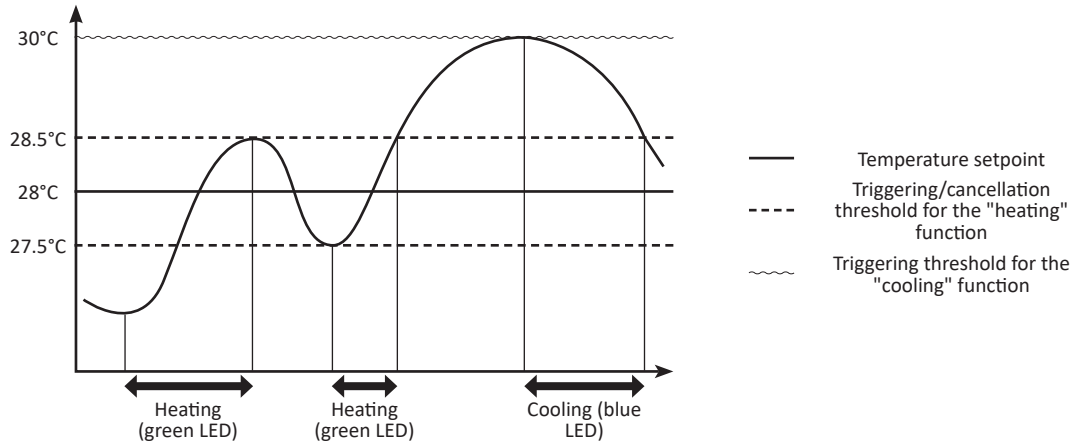

- From the main screen (where the measured water temperature is displayed), press and hold . "COOL" is displayed on the screen.
- Press and release , depending on the "Cooling" function status (activated or deactivated), the screen displays "On" (= activated) or "Off" (= deactivated). If necessary, press and release or to switch to the status ("On" or "Off") that is required.



- When the "Cooling" function is activated, the LED strip flashes blue 3 times.







- Once the "Cooling" function is activated or deactivated, press several times to return to the main screen (where the measured water temperature is displayed).

## 2.4.4 Using and selecting the different active operating modes

In "Heating" mode, the heat pump has 3 active operating modes for adjusting its operating speed to the power that is required and the mode that is selected.



Depending on the selected operating mode ("*BOOST*", "*SMART*" or "*ECOSILENCE*"), the power delivered by the heat pump can vary over a predefined range (depending on the speed of its compressor and fan).

The number of lit LEDs on the strip reflects the compressor's actual operating speed. This feature is particularly useful in the "*SMART*" and "*ECOSILENCE*" modes to see if the machine is operating at its maximum over the predefined power range or, on the contrary, at a reduced power level.

|                             |   | Active operating mode   |  |  |
|-----------------------------|---|---|--|--|
|                             |   | ▷ <i>BOOST</i>  | ▷ <i>SMART</i>   | ▷ <i>ECOSILENCE</i>  |
| Compressor operating speed* | HIGH<br>100%                                |  |  or  or  |  or  |
|                             | MID<br>75%                                  |   |  |  |
|                             | LOW<br>50%                                  |   |  |  |
|                             |   | The LED strip goes up to "HIGH"   | The LED strip fluctuates between "LOW", "MID" and "HIGH"   | The LED strip fluctuates between "LOW" and "MID"   |
| Status                      | Heating                                     |   |  |  |
| Objective                   | Quickly increasing the setpoint temperature | Intelligently controlling the operating speed                                     |  | Operating the most economically and quietly  |
|                             |   | Automatically adapting the power to requirements                                  |  |  |
| When to use                 | When commissioning the pool                 | To maintain the temperature   |  |  |
|                             |   | To avoid having to intervene on the appliance                                     | To benefit from quiet operation when little heating is required  |  |

\* The compressor speed directly affects the appliance's power output.

To select the active operating mode:

- From the main screen (where the measured water temperature is displayed), press . The indicator ▷ stops in front of one of the 3 operating modes ("*BOOST*", "*SMART*" or "*ECOSILENCE*").
- Press  until reaching the desired mode. Once the indicator ▷ is placed in front of the desired operating mode, it is confirmed automatically.



## 2.5 | Connecting to the iAquaLink™ app

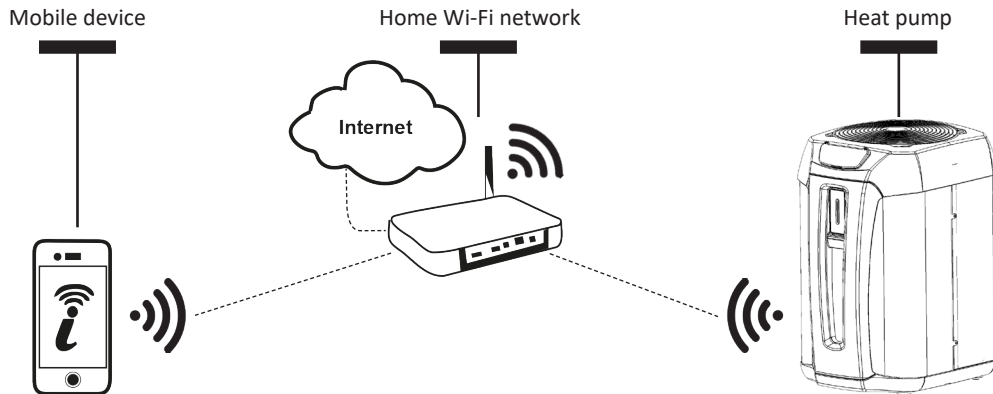

The Z550iQ heat pump can be remotely controlled from a smartphone or tablet, via the iAquaLink™ app available for iOS and Android systems.

EN



**Before connecting to the iAquaLink™ app, ensure that you:**

- Use a Wi-Fi-enabled smartphone or tablet.
- Use a Wi-Fi network with a reasonably strong signal when connecting to the heat pump: the Wi-Fi signal must be detectable at the place where the appliance is used. If this is not the case, a technical solution must be provided to amplify the existing signal.
- Rest close to the appliance and have your home Wi-Fi network password at the ready.

1. Download the iAquaLink™ app from the App Store (iOS) or Google Play Store (Android) then create an iAquaLink™ account (if the app is already installed, move onto the next step).
2. Open the app then add the heat pump to the list of appliances by clicking on the icon ⊕ (top right of the screen) and follow the steps described on the smartphone or tablet.



## 3 Maintenance

### 3.1 I Winterising



- Winterising is vital to prevent the condenser breaking due to freezing. This is not covered by the warranty.
- To avoid damaging the appliance with condensation, do not fully cover it; a winterising cover is provided.

- Set the regulator to "standby" mode by pressing and holding  for 3 seconds and disconnect the power supply,
- Open valve B,
- Close valves A and C and open valves D and E (if present),
- Make sure that there is no water circulating in the heat pump,
- Drain the water from the condenser (risk of freezing) by unscrewing the two water inlet and outlet connectors on the back of the heat pump,
- In the case of full winterising for the pool (complete shutdown of the filtration system, bleed the filtration circuit or even pool drainage): re-fit the two connectors by one turn to prevent any foreign bodies from getting into the condenser,
- In the case of winterising for the heat pump only (shutdown of the heating only, the filtration keeps running): to not tighten the connectors but add 2 caps (provided) on the condenser's water inlets and outlets.
- We recommend that you put the aired winterising micro cover (provided) on the heat pump.

### 3.2 I Maintenance



- Before any maintenance work on the appliance, you must cut the electricity supply as there is a risk of electric shock which may cause material damage, serious injury or even death.
- Before any maintenance, troubleshooting or repair operation, deactivating the modem's Wi-Fi connection is recommended to avoid any risk of the appliance being remotely controlled.
- Do not disconnect the electricity supply when the appliance is running.
- If the electric power supply is interrupted, wait a minute before restoring power to the appliance.
- It is recommended that the appliance undergo general servicing at least on a yearly basis to ensure proper operation, maintain performance levels and potentially prevent certain failures. These operations are carried out at the user's expense by a technician.

#### 3.2.1 User maintenance

- Make sure that the ventilation grid is not blocked by any foreign bodies.
- Clean the evaporator (for location see § "5.3 I Dimensions and marking") using a soft brush and a fresh water spray (disconnect the power cable); do not fold over the metal wings, then clean the condensate drainage line to remove any impurities that may be blocking it.
- Make sure that the switch box's ventilation grid is clean.
- Do not use a high pressure jet. Do not spray with rain water, salt water or water which is full of minerals.
- Clean the outside of the appliance; do not use any solvent-based products. We can provide you with a specific cleaning kit as an accessory: the PAC NET, see § "5.1 I Description".

#### 3.2.2 Maintenance to be carried out by a qualified technician

- Check that the control system is operating correctly.
- Check that the condensates flow correctly when the appliance is in operation.
- Check the safety mechanisms.
- Check the connection of the metal masses to the earth.
- Check that the electrical cables are correctly tightened and connected and that the switch box is clean.



## 4 Troubleshooting





























- Before you contact the retailer, carry out these few simple checks using the following tables if a problem occurs.
- If the problem is not resolved, contact your retailer.
- : Actions to be performed by a qualified technician only

### 4.1 I Appliance behaviour

|   |   |
|---|---|
| The appliance does not start heating straight away                                  | <ul style="list-style-type: none"> <li>• On start-up, the appliance remains "paused" for 30 seconds before it starts operating.</li> <li>• When the setpoint temperature is reached, the appliance stops heating: the water temperature is higher than or equal to the setpoint temperature.</li> <li>• When the water flow rate is zero or is not enough, the appliance stops: check that the water is circulating correctly in the appliance and that the hydraulic connections are correct.</li> <li>• The appliance stops when the outdoor temperature falls below -12 °C.</li> <li>• The appliance may have detected an operating fault (see § "4.2 I Error code display").</li> <li>• If you have checked these points and the problem persists: contact your retailer.</li> </ul>  |
| The appliance is discharging water  | <ul style="list-style-type: none"> <li>• Often called condensates, this water is the moisture contained in the air which condenses on contact with certain cold mechanisms in the appliance, especially on the evaporator. The damper the air, the more condensates your appliance will produce (your appliance may drain several litres of water per day). This water is retrieved by the base of the appliance and drained through the holes.</li> <li>• To check that the water is not coming from a leak in the pool circuit on the appliance, shut it down and run the filter pump to circulate water in the appliance. If the water continues to flow through the condensate drainage lines, there is a water leak in the appliance; contact your retailer.</li> </ul>  |
| The evaporator is iced over   | <ul style="list-style-type: none"> <li>• The appliance will soon switch to its defrost cycle to melt the ice.</li> <li>• If the appliance cannot manage to defrost its evaporator, it will stop itself; this means that the outdoor temperature is too low (below -12°C).</li> </ul>  |
| The appliance is "smoking"  | <ul style="list-style-type: none"> <li>• This may occur when the appliance is in a defrost cycle and the water is converted to gas.</li> <li>• If the appliance is not in its defrost cycle, this is not normal. Switch off and disconnect the appliance immediately and contact your retailer.</li> </ul>  |
| The appliance is not working  | <ul style="list-style-type: none"> <li>•  If there is no display, check the supply voltage and the F1 fuse.</li> <li>• When the setpoint temperature is reached, the appliance stops heating: the water temperature is higher than or equal to the setpoint temperature.</li> <li>• When the water flow rate is zero or is not enough, the appliance stops: check that the water is circulating correctly in the appliance.</li> <li>• The appliance stops when the outdoor temperature falls below -12 °C.</li> <li>• The appliance may have detected an operating fault (see § "4.2 I Error code display").</li> <li>• The appliance is in an empty time range. Deactivate the "time range" mode to launch manual operation.</li> </ul>   |
| The appliance is working but the water temperature does not increase                | <ul style="list-style-type: none"> <li>• The operating mode is not powerful enough (appliance in "ECOSILENCE" or "SMART" mode). Switch to "BOOST" mode and set the filtration to 24/24 manual while the temperature rises.</li> <li>• The appliance may have detected an operating fault (see § "4.2 I Error code display").</li> <li>• Check that the automatic filling valve is not stuck in open position; this will keep supplying cold water into the pool and will prevent the temperature from rising.</li> <li>• There is too much heat loss as the air is cool. Install a heat insulated cover on the pool.</li> <li>• The appliance is unable to capture enough calories as its evaporator is clogged with dirt. Clean it to restore its performances (see § "3.2 I Maintenance").</li> <li>• Check that the external environment is not hindering the heat pump (see § "1 Installation").</li> <li>•  Check that the appliance is the right size for this pool and its environment.</li> </ul> |
| The fan is running but the compressor stops from time to time with no error message | <ul style="list-style-type: none"> <li>• If the outdoor temperature is low, the appliance will perform defrost cycles.</li> <li>• The appliance is unable to capture enough calories as its evaporator is clogged with dirt. Clean it to restore its performances (see § "3.2 I Maintenance").</li> </ul>   |
| The appliance trips the circuit breaker   | <ul style="list-style-type: none"> <li>•  Check that the circuit breaker is correctly dimensioned and that the cable section used is correct (see § "5.2 I Technical data").</li> <li>•  The supply voltage is too low; contact your electricity supplier.</li> </ul>   |

## 4.2 | Error code display

| Display   | Possible causes  | Solutions  | Resetting  |
|---|--|--|--|
| <b>E04</b><br><i>Low pressure fault on cooling circuit</i>                                  | Pressure fault in the low pressure circuit (if problem persists after resetting) | Call a qualified technician  | <ul style="list-style-type: none"> <li>LED "steady red" = automatic</li> <li>LED "flashing red" = press </li> </ul>   |
|   | Exchanger clogged with dirt  | Clean the water exchanger  |  |
| <b>E05</b><br><i>Cooling circuit high pressure fault</i>                                    | Insufficient water flow  |  Increase flow using the by-pass, check that the pool filter is not clogged | <ul style="list-style-type: none"> <li>LED "steady red" = automatic</li> <li>LED "flashing red" = press </li> </ul>   |
|   | Air and water emulsion has passed into the appliance                             |  Check the pool's hydraulic circuit   |  |
|   | Flow switch blocked  |  Check the flow switch  |  |
|   | Sensor is faulty or offline  |  Reconnect or change the sensor   | Press   |
| <b>E06</b><br><i>Compressor discharge temperature fault</i>                                 | Compressor discharge valve temperature too high                                  | Call a qualified technician  | <ul style="list-style-type: none"> <li>LED "steady red" = automatic</li> <li>LED "flashing red" = press </li> </ul>   |
|   | Fan operating incorrectly  |  Replace the fan motor  |  |
| <b>E07</b><br><i>ST1 sensor fault - water inlet sensor</i>                                  | Sensor is faulty or offline (J46 connector)                                      |  Reconnect or change the sensor   | Press   |
| <b>E08</b><br><i>ST4 sensor fault - fluid line sensor</i>                                   | Sensor is faulty or offline (J16 connector)                                      |  Reconnect or change the sensor  | Press    |
| <b>E09</b><br><i>ST3 sensor fault - defrost sensor</i>                                      | Sensor is faulty or offline (J14 connector)                                      |  Reconnect or change the sensor   | Press   |
| <b>E10</b><br><i>ST2 sensor fault - air inlet sensor</i>                                    | Sensor is faulty or offline (J12 connector)                                      |  Reconnect or change the sensor   | Press   |
| <b>E11</b><br><i>ST5 sensor fault - compressor discharge sensor</i>                         | Sensor is faulty or offline (J13 connector)                                      |  Reconnect or change the sensor   | Press   |
| <b>E12</b><br><i>Communication fault between the regulation board and the display board</i> | Bad connection between the boards A1 - A4 - A5                                   |  Check the RJ45 cables between A1 - A4 et A4 - A5                         | <ul style="list-style-type: none"> <li>LED "steady red" = automatic</li> <li>LED "flashing red" = press </li> </ul> |
|   | Faulty boards  |  Replace the boards   |  |
| <b>E14</b><br><i>Overheating of compressor driver electronic board</i>                      | Radiator clogged   | Check the condition of the radiator to the rear of the electrical box  | <ul style="list-style-type: none"> <li>LED "steady red" = automatic</li> <li>LED "flashing red" = press </li> </ul> |
|   | Fan operating incorrectly  | Check that the air flow is correct   |  |
|   | Faulty component on the Driver   |  Replace the Driver   |  |
| <b>E15</b><br><i>Automatic protection against electrical network instabilities</i>          | Electrical network overvoltage or interruption or drop in the network voltage    |  Check the quality of the electrical network                              | <ul style="list-style-type: none"> <li>LED "steady red" = automatic</li> <li>LED "flashing red" = press </li> </ul> |
|   | Incorrect earthing   |  Check that the earth cables and power cables are correctly connected     |  |

| Display   | Possible causes                             | Solutions   | Resetting   |
|---|---|---|---|
| <b>E16 / E17</b><br><i>Error on the fan motor</i>             | Fan motor disconnected                      | Check the fan motor connector. If the problem persists, call a qualified technician         | <ul style="list-style-type: none"> <li>LED "steady red" = automatic</li> <li>LED "flashing red" = press </li> </ul> |
|   | Fan motor damaged                           | Replace the fan motor   |   |
| <b>E18</b><br><i>Problem relayed by the compressor driver</i> | Electrical supply over or undervoltage      | Check the electrical supply voltage (maximum 240V ±10%)                                     | <ul style="list-style-type: none"> <li>LED "steady red" = automatic</li> <li>LED "flashing red" = press </li> </ul> |
|   | Incorrect compressor winding value          | Check the resistance value of the windings (anticipated value ≈ 1 oHm)                      |   |
| <b>E19</b><br><i>Driver - compressor communication fault</i>  | Bad connection between the A1 and A2 boards | Check that the CONIN (A1 board) and AB (A2 driver board) connectors are correctly connected | <ul style="list-style-type: none"> <li>LED "steady red" = automatic</li> <li>LED "flashing red" = press </li> </ul> |
|   | Board power supply fault                    | Check the boards' power supply  |   |
|   | Faulty boards                               | Replace the A1 (regulation board) and A2 (compressor driver) boards                         | Automatic   |
| <b>E20</b><br><i>Main board not configured</i>                | Board settings                              | Enter the appliance model in the settings   | Automatic   |

EN

### ➤ 4.3 | Lighting of LEDs on the printed circuit board

|  | LED5 | LED4 | LED3 | LED2 | LED1 |
|--|------|------|------|------|------|
| No errors<br>Appliance<br>switched off | ○    |      |      |      |      |
| Error 04                               | ○    |      |      |      | ○    |
| Error 05                               | ○    |      |      | ○    |      |
| Error 06                               | ○    |      |      | ○    | ○    |
| Error 07                               | ○    |      | ○    |      |      |
| Error 08                               | ○    |      | ○    |      | ○    |
| Error 09                               | ○    |      | ○    | ○    |      |
| Error 10                               | ○    |      | ○    | ○    | ○    |
| Error 11                               | ○    | ○    |      |      |      |
| Error 12                               | ○    | ●    | ●    | ●    | ●    |
| Error 14                               | ○    | ○    | ○    |      | ○    |
| Error 15                               | ○    | ○    | ○    | ○    |      |
| Error 16                               | ○    | ○    | ○    | ○    | ○    |
| Error 17                               | ○    |      |      |      | ●    |
| Error 18                               | ○    |      |      | ●    |      |
| Error 19                               | ○    |      |      | ●    | ●    |
| Error 20                               | ○    |      | ●    |      |      |

●: LED on

○: Flashing LED

Empty: LED off





| Symbol     | Description                      |
|------------|----------------------------------|
| A1         | Electronic regulation board      |
| A2         | Display board (HMI)              |
| A3         | Fan board                        |
| A4         | Compressor electronic board      |
| A5         | Splitter board                   |
| A6         | LED board                        |
| A7         | Filter board                     |
| A8         | Fan filter board                 |
| BLK        | Black                            |
| BLU        | Blue                             |
| BRN        | Brown                            |
| C1         | Fan condenser                    |
| C2         | Second speed condenser           |
| C3         | Compressor condenser             |
| CM         | Compressor                       |
| EXP VALVE  | Electronic expansion valve       |
| F1 - F2    | Fuse                             |
| FAN        | Fan motor                        |
| FAN HEATER | Conveyor resistor                |
| GRN/YEL    | Green/Yellow                     |
| HEATER     | Anti-freeze resistor (condenser) |
| HP         | High pressure switch             |
| J1         | Flow switch                      |
| LED        | LED electronic board             |
| LP         | Low pressure switch              |
| M1         | Fan motor                        |
| M2         | Compressor motor                 |
| ORG        | Orange                           |
| PNK        | Pink                             |
| R1         | Pump switch                      |
| R2         | Compressor switch                |
| R3         | Fan motor switch                 |
| RED        | Red                              |
| REV VALV   | Reversal valve                   |
| ST1        | Water flow regulation sensor     |
| ST2        | Anti-freeze sensor               |
| ST3        | Defrost sensor                   |
| ST4        | Fluid temperature sensor         |
| ST5        | Discharge temperature sensor     |
| TP1        | Terminal board                   |
| TP2        | Terminal board                   |
| V1 - V2    | Varistor                         |
| V4         | Gas discharge pipe               |
| VLT        | Violet                           |
| WHT        | White                            |
| YEL        | Yellow                           |





## 5 Characteristics

### 5.1 | Description

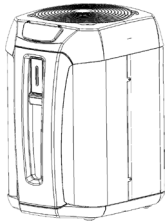
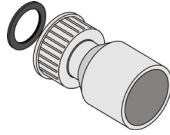
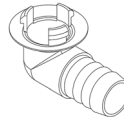
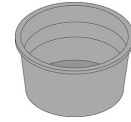
**A****B****C****D****E****F****G****H****EN**

| A |                                | Z550iQ |
|---|--------------------------------|--------|
| B | Ø50 connector to be glued (x2) | ✓      |
| C | Condensate drainage kit (Ø18)  | ✓      |
| D | Winterising cap (x2)           | ✓      |
| E | Winterising cover              | ✓      |
|   | Heating priority               | ✓      |
| F | Technical room kit             | +      |
| G | Condensation tray              | +      |
| H | PAC NET<br>(cleaning product)  | +      |

✓: Included

+: Available as an accessory

## 5.2 I Technical data

| Z550iQ  |                          | MD4   | MD5                        | TD5                        | MD8                        | TD8        |
|---|--------------------------|---|----------------------------|----------------------------|----------------------------|------------|
| <b>Performances: air at 28°C / water at 28°C / humidity at 80 %</b> |                          |   |                            |                            |                            |            |
| Power output (max-min speed)  | kW                       | 12.5 - 7.9  | 15 - 7.6                   | 15.5 - 7.1                 | 20 - 10.8                  | 20 - 11.2  |
| Power consumed (max-min speed)                                      | kW                       | 2 - 1.05  | 2.5 - 1.05                 | 2.4 - 0.65                 | 3.6 - 1.55                 | 3.5 - 1.55 |
| Average COP (max-min speed)   |                          | 6.1 - 7.6   | 5.9 - 7.4                  | 6.6 - 10.9                 | 5.5 - 7                    | 5.8 - 7.7  |
| <b>Performances: air at 15°C / water at 26°C / humidity at 70 %</b> |                          |   |                            |                            |                            |            |
| Power output (max-min speed)  | kW                       | 9.5 - 5.5   | 11.5 - 5.8                 |                            | 15 - 7.8                   | 15 - 8.2   |
| Power consumed (max-min speed)                                      | kW                       | 1.9 - 0.95  | 2.5 - 1.1                  | 2.4 - 0.8                  | 3.7 - 1.65                 | 3.1 - 1.4  |
| Average COP (max-min speed)   |                          | 4.9 - 5.7   | 4.6 - 5.4                  | 4.9 - 7.2                  | 4.1 - 4.8                  | 4.9 - 6    |
| <b>Technical specifications</b>                                     |                          |   |                            |                            |                            |            |
| Operating temperature   | Air                      | In "heating" mode: from -12 to 40°C<br>In "cooling" mode: from 10 to 40°C |                            |                            |                            |            |
|   | Water                    | 10 to 32 °C   |                            |                            |                            |            |
| Power supply  |                          | 220 - 240V / 1N~ / 50-60Hz  | 380 - 400V / 3N~ / 50-60Hz | 220 - 240V / 1N~ / 50-60Hz | 380 - 400V / 3N~ / 50-60Hz |            |
| Admissible variation in voltage                                     |                          | ± 6 % (during operation)  |                            |                            |                            |            |
| Class*  |                          | I   |                            |                            |                            |            |
| Pollution degree*   |                          | 2   |                            |                            |                            |            |
| Overvoltage category*   |                          | II  |                            |                            |                            |            |
| Nominal electric current requirement                                | A                        | 9.6 - 5   | 12 - 4.9                   | 5.9 - 1.6                  | 17.6 - 7.5                 | 6 - 3.5    |
| Maximum electric current requirement                                | A                        | 12.5  | 13.8                       | 6                          | 20                         | 8          |
| Minimum cable section**   | mm <sup>2</sup>          | 3x2.5   |                            | 5x2.5                      | 3x6                        | 5x2.5      |
|   |                          | 3G2.5   |                            | 5G2.5                      | 3G6                        | 5G2.5      |
| Hydraulic connections   |                          | 1/2 union PVC Ø50 to be glued   |                            |                            |                            |            |
| Service pressure (refrigerant/ water)                               | bar                      | 42 / 2  |                            |                            |                            |            |
|   | MPa                      | 4.2 / 0.2   |                            |                            |                            |            |
| Sound power (max-min)   | db(A)                    | 62 - 54   | 66 - 57                    | 66 - 56                    | 67 - 53                    | 67 - 57    |
| Sound pressure at 10m (max-min)                                     | db(A)                    | 31 - 23   | 35 - 26                    | 35 - 25                    | 36 - 22                    | 36 - 26    |
| Head loss   | mWG                      | 1.5   |                            |                            |                            |            |
| Recommended water flow  | m <sup>3</sup> /h        | 4   | 5                          |                            | 6                          |            |
| Type of cooling fluid   |                          | R410A   |                            |                            |                            |            |
| Cooling fluid load  | kg                       | 1.3   | 1.5                        |                            | 2.4                        | 2.6        |
|   | Tonn CO <sub>2</sub> eq. | 2.72  | 3.1                        |                            | 5.01                       | 5.43       |
| Approximate weight  | kg                       | 54  | 60                         | 60                         | 70                         | 70         |
| Frequency bands   | GHz                      | 2.400 - 2.497   |                            |                            |                            |            |
| Radiofrequency emission power                                       | dBm                      | +19.5   |                            |                            |                            |            |
| Protection rating   |                          | IP24  |                            |                            |                            |            |

\* These specifications have been determined based on the requirements defined in standards IEC/EN 60335-1 and IEC/EN 60035-2-40 on the safety of electrical appliances for household and similar purposes.

\*\* Values provided for information purposes for a maximum length of 20 metres (calculation base: NFC15-100), must be checked and adapted to the installation conditions and standards of the installation country.

➤ 5.3 I Dimensions and marking

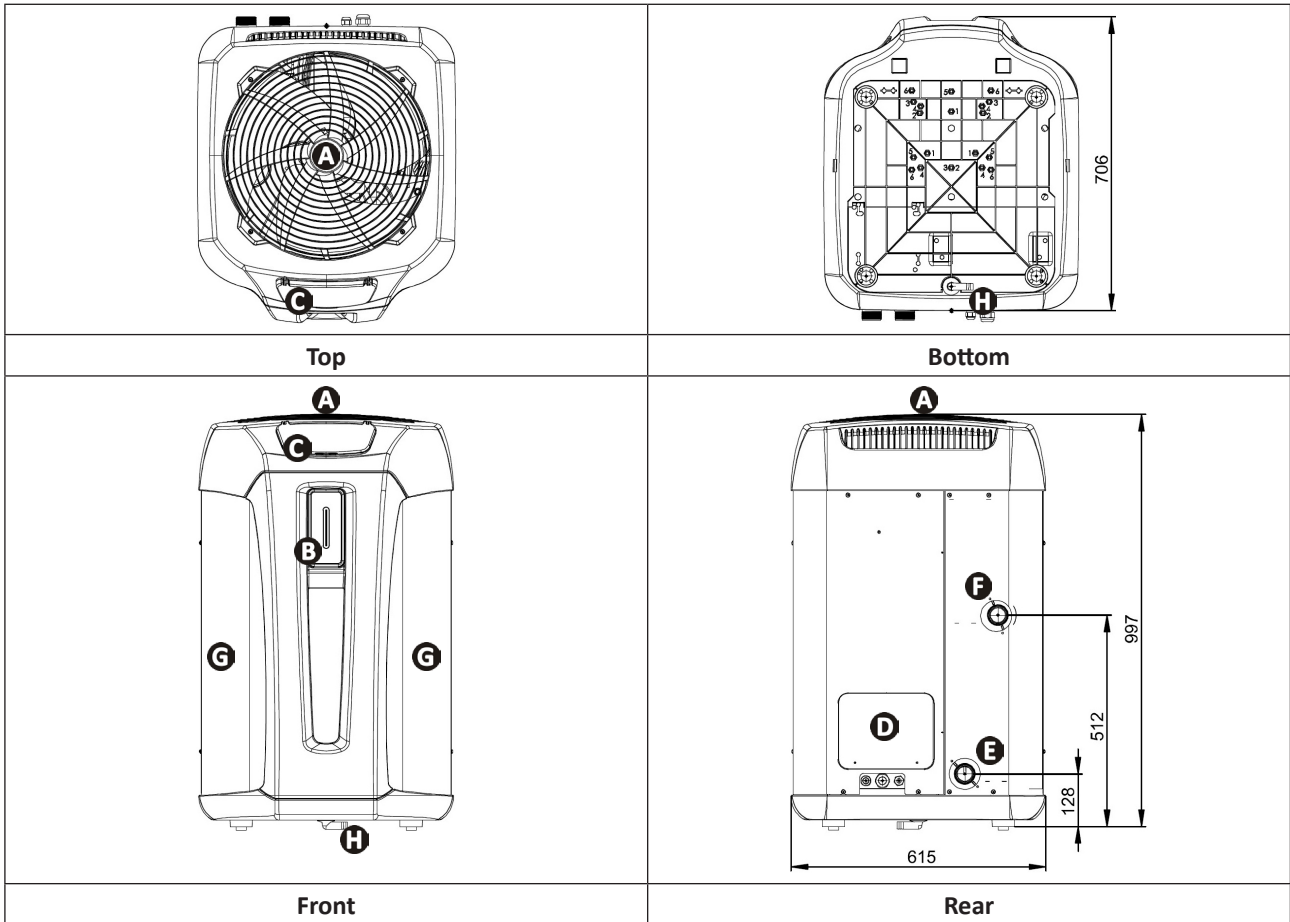

EN

|          |                       |
|----------|-----------------------|
| <b>A</b> | Grid                  |
| <b>B</b> | LED strip             |
| <b>C</b> | User interface        |
| <b>D</b> | Technical access door |
| <b>E</b> | Pool water inlet      |
| <b>F</b> | Pool water outlet     |
| <b>G</b> | Evaporator            |
| <b>H</b> | Condensates drain     |

Votre revendeur  
*Your retailer*

Modèle appareil  
*Appliance model*

Numéro de série  
*Serial number*

|  |
|--|
|  |
|  |
|  |

Pour plus d'informations, enregistrement produit et support client :  
*For more information, product registration and customer support:*

**[www.zodiac.com](http://www.zodiac.com)**

